



Radiolink plus



Radiolink plus is designed to be rigged with Crosby standard shackles - DNV-GL type approved wireless tension load cell capable of weighing and dynamic load monitoring in capacities from 1t to 500t – from stock with an ATEX and IECEx version available for hazardous areas, zones 0, 1 & 2.

Two versions of the RLP are available:

- Long range 2.4GHz version providing industry-leading wireless range of 1000m or 3280ft to SP's SW-HHP handheld or software options.
- Bluetooth output and can be connected to any smart phone running our free HHP app on iOS or Android, at ranges up to 100m or 328ft.

Constructed from high-quality aerospace grade aluminium, the RLP features an advanced internal design structure. This design provides the product with an unrivalled strength to weight ratio. The use of a separate internal sealed enclosure administers the load cell's electronic components with IP67 or NEMA6 environmental protection, even with the battery cover plate missing. All these features makes it an industry-leading dynamometer, suitable for use in the harshest of environments.

The versatile RLP is able to provide an update rate of 3Hz and can be easily configured to run at industry-leading speeds of up to 200Hz, making it ideal for dynamic force measurement.

Decades of development into this product include many stand out features such as SP's unique strain gauging method that helps compensate for wire rope torque when the Radiolink is loaded. The Radiolink plus tension load cell can also be used in combination with Crosby | Straightpoint 'INSIGHT' high speed wireless data logging software allowing for simultaneous control, display and real time data logging of up to 126 Crosby | Straightpoint wireless load cells.

A full array of wireless accessories are also available including wireless score board, overload alarm and base station with analogue (4-20mA) or 2 relay or RS485 ASCII outputs.

Features and benefits:

- Proprietary 2.4 GHz Wireless
- Remote On-Off from handheld display or software
- ATEX Zones 0, 1 & 2 available
- Design validated by F.E.A.
- 2-year warranty
- DNV-GL Type Approval
- Complies with ASME B30.26
- Bluetooth option is available and is supplied with a free HHP App for iOS and Android

Accessories available for the handheld:

Wall or Cab Mount Bracket
SP Crosby Part Nos. **SU3282 2789228**

Rugged Rubber Boot
SP Crosby Part Nos. **SU4045 2789232**

Also available with hazardous area approval. Zones 0, 1 & 2



ATEX / IECEX

Ex ia II C T4 Ga

Certification numbers:

RLP ATEX

IECEX SIR 15.0071X / Sira 15ATEX2195X

SW-HHP ATEX

IECEX SIR 15.0072X / Sira 15ATEX2196X

Add 'ATEX' to the part number when ordering ATEX/IECEX products. For example: RLP6T5-ATEX

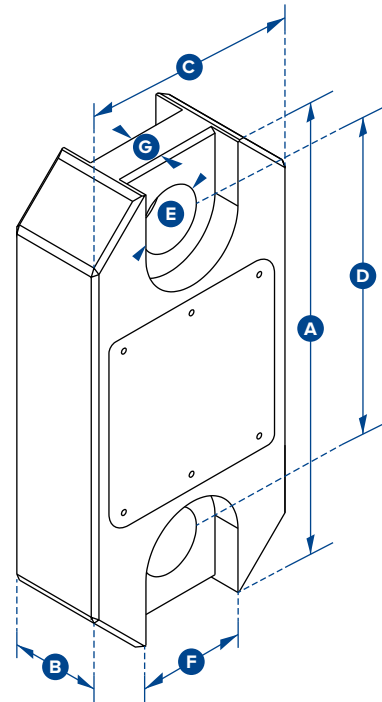

Part Numbers															
SP	RLP1T	RLP2T5	RLP6T5	RLP12T	RLP25T	RLP35T	RLP55T	RLP75T	RLP100T	RLP150T	RLP200T	RLP250T	RLP300T	RLP500T	
Crosby	2789084	2789089	2789094	2789082	2789088	2789091	2789093	2789095	2789081	2789083	2789085	2789087	2789090	2789092	
Capacity	1,000kg 2200lb	2.5te 5500lb	6.5te 14300lb	12te 26000lb	25te 55000lb	35te 77000lb	55te 120000lb	75te 165000lb	100te 220000lb	150te 330000lb	200te 440000lb	250te 550000lb	300te 660000lb	500te 1100000lb	
Resolution	0.5kg 1lb	0.001te 2lb	0.001te 2lb	0.002te 5lb	0.005te 10lb	0.005te 10lb	0.01te 20lb	0.01te 20lb	0.05te 100lb	0.05te 100lb	0.1te 200lb	0.1te 200lb	0.1te 200lb	0.1te 200lb	
Units	kg lb	te lb	te lb	te lb	te lb	te lb	te lb	te lb	te lb	te lb	te lb	te lb	te lb	te lb	
Weight	1.5kg 3.3lb	1.5kg 3.3lb	2.4kg 5.3lb	3.7kg 8.2lb	5kg 11lb	8.6kg 19lb	13kg 28.7lb	16kg 35.3lb	34kg 75lb	46kg 101.4lb	82kg 180.8lb	82kg 180.8lb	118kg 260lb	193kg 425.5lb	
Safety Factor	12:1	7:1	7:1	7:1	5:1	5:1	5:1	5:1	5:1	5:1	5:1	4:1	5:1	5:1	
Battery Type	Handheld 2 x AA / Load cell 4 x AA														
Battery Life	Handheld - 40 hours / Load cell 1200 hours continuous (Load cell 500 hours if Bluetooth)														
Display Type	240 x 128 pixel Multi-line dot matrix with backlight														
Operating Temp	-10°C to +50°C or 14°F to 122°F														
Accuracy	±0.1% of full scale														
Frequency	2.4 GHz														
System Range	1000 metres or 3280 feet (100 metres or 328 feet if Bluetooth)														
Data Rate	3 Hz - up to 200 Hz can be ordered for dynamic load monitoring applications														
Protection	IP67 or NEMA6														
Dimension A	204 8.03"	204 8.03"	249 9.80"	305 12.01"	340 13.39"	393 15.47"	424 16.69"	470 18.50"	608 23.94"	670 26.38"	700 27.56"	700 27.56"	806 31.73"	930 36.61"	
Dimension B	43 1.69"	43 1.69"	43 1.69"	47 1.85"	60 2.36"	75 2.95"	75 2.95"	75 2.95"	99 3.90"	99 3.90"	144 5.67"	144 5.67"	150 5.91"	150 5.91"	
Dimension C	104 4.09"	104 4.09"	113 4.45"	113 4.45"	115 4.53"	126 4.96"	180 7.09"	202 7.95"	255 10.04"	303 11.93"	350 13.78"	350 13.78"	426 16.77"	570 22.44"	
Dimension D	146 5.75"	146 5.75"	165 6.50"	193 7.60"	215 8.46"	225 8.86"	230 9.06"	260 10.24"	320 12.60"	360 14.17"	350 13.78"	350 13.78"	350 13.78"	450 17.72"	
Dimension ØE	24.5 0.96"	24.5 0.96"	38 1.50"	47.5 1.87"	55 2.17"	60 2.36"	76 2.99"	76 2.99"	109 4.29"	109 4.29"	145 5.71"	145 5.71"	160 6.30"	200 7.87"	
Dimension F	48 1.89"	48 1.89"	65 2.60"	Not relevant in this capacity											
Dimension G	19 0.75"	19 0.75"	32 1.26"												
Crosby Shackle	G2130						G2140						G2160		
Loading Pin Ø	19 3/4"	19 3/4"	25 1"	35 1 3/8"	51 2"	57 2 1/4"	57 2 1/4"	70 2 3/4"	83 3 1/4"	95 3 3/4"	121 4 3/4"	127 5"	152 6"	180 7 1/8"	